

The KE Series are for use in high temperature applications where the process temperatures may reach 538°C (1000°F) such as high temperature engineered polymers. The K Series utilizes standard melt pressure principles and construction, but uses a near incompressible NAK (Sodium Potassium) for pressure transmission. The thick film extensimetric technology of KE series provides to transform the physical quantity "pressure" into an electrical signal, in this case 4 to 20 mA. The SIL2 certified version makes the product suitable for use in the Functional Safety applications, particularly in the process plants for the production of polymers, where it is an essential requirement.

MAIN FEATURES

- Pressure ranges from:
 - 0-17 to 0-1000 bar / 0-250 to 0-15000 psi
- Accuracy: $\pm 0.25\%$ FS (H); $\pm 0.5\%$ FS (M)
- Hydraulic transmission system for pressure signal guarantees stability at working temperature (NaK). Liquid conforming to RoHS Directive.
- SIL2 approvals for Functional Safety
- 1/2-20UNF, M18x1.5 standard threads; other types available on request
- Autozero function on board / external option
- Stem drift Autocompensation function (SP version)
- Inconel 718 diaphragm with GTP+ coating for temperatures up to 538°C (1000°F)
- 15-5 PH diaphragm with GTP+ coating for temperatures up to 400°C (750°F)
- Hastelloy C276 diaphragm for temperatures up to 300°C (570°F)
- 17-7 PH corrugated diaphragm with GTP+ coating for ranges below 100bar-1500psi up to 400°C (750°F)
- Stem material: 17-4 PH

GTP+ (advanced protection)

Coating with high resistance against corrosion, abrasion and high temperature

AUTOZERO FUNCTION

All signal variations in the absence of pressure can be eliminated by using the Autozero function.

This function is activated by closing a magnetic contact located on the transmitter housing.

The procedure is permitted only with pressure at zero.

AUTO-COMPENSATED INFLUENCE OF MELT TEMPERATURE

Thanks to internal self-compensation, the KSP series transmitter cancels the effect of pressure signal variation caused by variation of Melt temperature.

This reduces at the minimum the read error caused by heating of the filling fluid (typical of all sensors built with "filled" technology).

The drift values declared in the version with Autocompensation are valid for media temperatures up to 500°C.

TECHNICAL SPECIFICATIONS

Accuracy (1)	H $\pm 0.25\%$FS (100...1000 bar) M $\pm 0.5\%$FS (17...1000 bar)
Resolution	Infinite
Measurement range	0..17 a 0..1000bar 0..250 a 0..15000psi
Maximum overpressure (without degrading performances)	2 x FS 1.5 x FS over 700bar/10000psi
Measurement principle	Extensimetric thick film
Power supply	10..30Vdc
Maximum current absorption	32mA
Insulation resistance (at 50Vdc)	>1000 MOhm
Output signal Full Scale FS	20mA
Zero balance (tolerance $\pm 0.25\%$ FS)	4mA
Zero signals adjustment (tolerance $\pm 0.25\%$ FS)	"Autozero" function
Span adjustment within $\pm 5\%$ FS	See Melt Manual
Maximum allowed load	See chart
Electronic response time (10...90% FS)	~ 1ms
Output noise (RMS 10-400Hz)	0.025% FS
Calibration signal	80% FS
Output short circuit and reverse polarity protection	YES
Compensated temperature range	0...+85°C
Operating temperature range	-30...+105°C
Storage temperature range	-40...+125°C
Thermal drift in compensated range: Zero / Calibration / Sensibility	0.02% FS/°C
Diaphragm maximum temperature	538°C 1000°F
Zero drift (zero)	$3.5\text{bar}/100^\circ\text{C}$ / $28\text{psi}/100^\circ\text{F}$
Zero drift temperature for Autocompensated version (SP) within the temperature range 20°C-500°C inclusive the drift temperature of the housing	$0.005\text{bar}/^\circ\text{C}$ $100 \leq p < 500\text{bar}</math>0.0022\% \text{FS}/^\circ\text{C}</math> p \geq 500\text{bar}</math>$
Thermocouple (model KE2)	STD : tipo "J" (isolated junction)
Protection degree (with 6-pole female connector CON300)	IP66
SIL2 certification	IEC/EN 62061 IEC 61508

FS = Full Scale Output

(1) BFSL method (Best Fit Straight Line): includes combined effects of Non-Linearity, Hysteresis and Repeatability (according to IEC 62828-2).

ELECTRICAL CONNECTIONS

CURRENT OUTPUT (4...20mA, 2 wires)

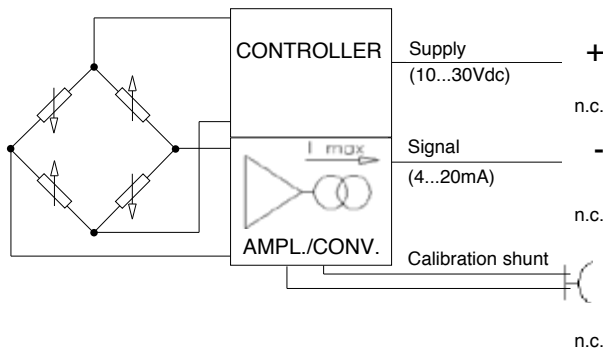

MAGNETIC AUTOZERO

6-pin	8-pin
A	B
C	A
B	D
D	C
E - F	E - F
	G - H

EXTERNAL AUTOZERO

6-pin	8-pin
A	B
C	A
B	D
D	C
E - F	E - F
	G - H

Connect the cable sheathing to the side of the instrument

LOAD DIAGRAM

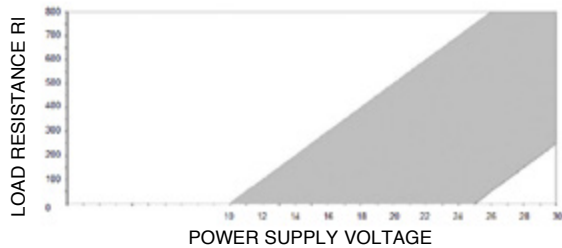

The diagram shows the optimum ratio between load and power supply for transmitters with 4...20mA output. For correct function, use a combination of load resistance and voltage that falls within the shaded area.

AUTOZERO FUNCTION

6-pin connector
VPT07RA10-6PT2
(PT02A-10-6P)

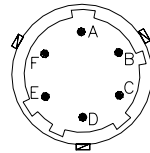

8-pin connector
PC02E-12-8P Bendix

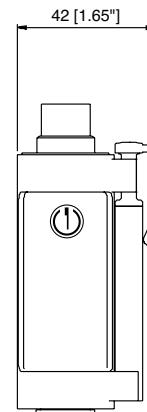
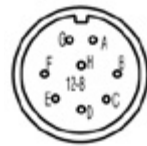

The Autozero function is activated through a magnetic contact (external magnet supplied with the sensor). See the manual for a complete Autozero function explanation.

ACCESSORIES

Connectors

6-pin female connector (IP66 protection degree)

8-pin female connector

Extension cables

6-pin connector with 8m (25 ft) cable

6-pin connector with 15m(50 ft) cable

6-pin connector with 25m (75 ft) cable

6-pin connector with 30m (100 ft) cable

8-pin connector with 8m (25 ft) cable

8-pin connector with 15m (50 ft) cable

8-pin connector with 25m (75 ft) cable

8-pin connector with 30m (100 ft) cable

Other lengths

Accessories

Mounting bracket

Dummy plug for 1/2-20 UNF

Dummy plug for M18x1,5

Drill kit for 1/2 -20 UNF

Drill kit for M18 x 1,5

Cleaning kit for 1/2-20 UNF

Cleaning kit for M18x1,5

Fixing pen clip

Autozero pen

Thermocouple for KE2 model

Type "J" (153mm - 6" rigid stem)

CON300

CON307

C08WLS

C15WLS

C25WLS

C30WLS

E08WLS

E15WLS

E25WLS

E30WLS

on request

SF18

SC12

SC18

KF12

KF18

CT12

CT18

PKIT309

PKIT312

TTER 601

Cable color code 6 wires

Conn.	Wire
A	Red
B	Black
C	White
D	Green
E	Blue
F	Orange

Codice colore cavo 8 wires

Conn.	Wire
A	White
B	Red
C	Green
D	Black
E	Blue
F	Orange
G	n.c.
H	n.c.

PROCESS FLANGE ADAPTER

The process flange adapter is a sensor accessory that allows for the installation of 1/2-20 UNF or M18x1.5 melt pressure sensor in a button seal style process mounting port. The adapter is made with an adapter body with different snout lengths plus an adapter flange available in different sizes (see tables and drawing below). Each combination of snout and flange is available according to the ordering information with a specific ordering code.

SPECIFICATIONS

- Pressure range: according to the selected sensor (up to 1000 bar/15000 psi max)
- Temperature range: according to the selected sensor
- Material of construction: 17-4PH Stainless steel

ADAPTER BODY

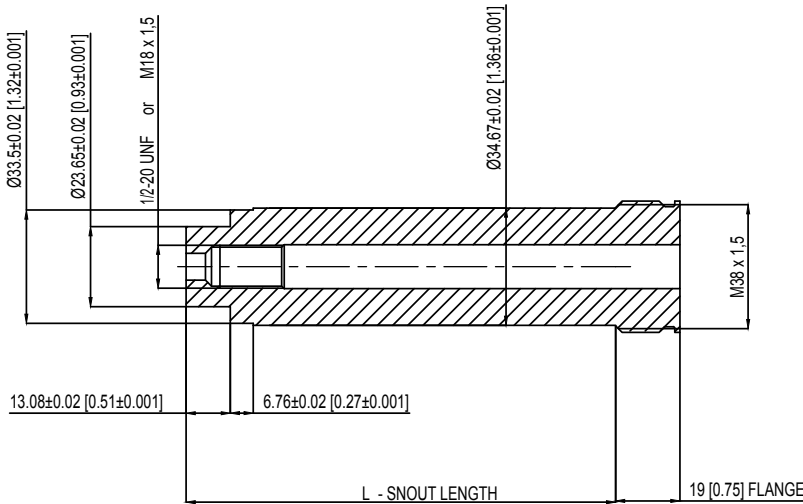

1/2-20 UNF	L - SNOUT LENGTH
STE1020	127 [5]
STE1021	51,6 [2,031]

M18 X 1,5	L - SNOUT LENGTH
STE1022	127 [5]
STE1023	51,6 [2,031]

ADAPTER FLANGE

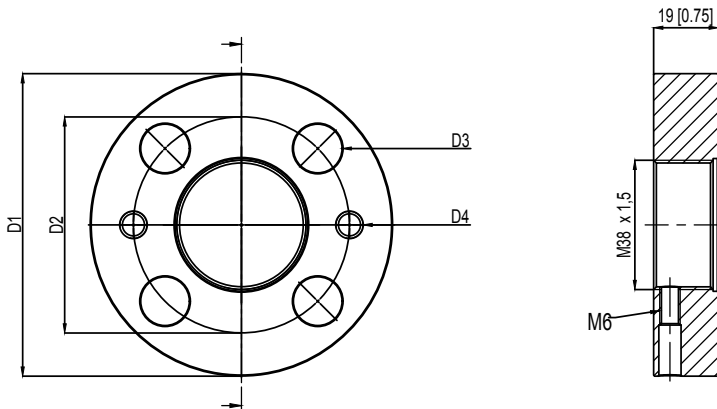

	FLA960	FLA961
D1	82,6 [3,25]	88,9 [3,50]
D2	54 [2,14]	63,5 [2,50]
D3	13,2 [0,52]	14,3 [0,56]
D4	5/16-18 UNC	5/16-18 UNC

ORDER CODE

KIT - 5 - 0 - 1

Snout length	
5 inch [127 mm]	5
2,031 inch [51,6 mm]	2

Flange type (see technical drawing)	
FLA960	0
FLA961	1

Thread dimensions	
1/2-20 UNF	1
M18 x 1,5	4

ADAPTER GASKETS			
Material	Dimensions	Max Pressure	Ord. Code
Aluminium	30.2 mm [1.19"] OD 24.1 mm [.950"] ID	200 bar/3000 psi	RON360
AISI 303 SS	30.2 mm [1.19"] OD 24.1 mm [.950"] ID	700 bar/10000 psi	RON361

Example:

KIT501

Process adapter with 5" snout length, 82.6 mm size flange, suitable for 1/2-20 UNF melt sensor

